



ENTERPRISE HD IP PHONE



USER GUIDE

UC803(P)

Version:1.0.3.59

Notices Information

Copyright

Copyright © 2005 - 2013 Nanjing Hanlong Technology CO., LTD. All rights reserved.

Nanjing Hanlong Technology Co., LTD. owns all the right to revise and change this document at any time. And all the illustrations and instructions in this paper are subject to the copyright protection of legal law. No parts of this document may be used or reproduced, transmitted by the third parties for any purposes without the express written permission of Nanjing Hanlong Technology Co., LTD.

When this document is made available on Hanlong's web page, Hanlong Technology Co., LTD. gives its right to download and print copies of this content only for private use as a user manual. No parts shall have the right to alter, modify or use as commercial means without the express written permission of Nanjing Hanlong Technology Co., LTD.

Safety cautions

To use the Phone follow the instructions in this manual.

To use the power adapter that delivered with the phone. Other power adapters may damage the phone.

The phone is only for indoor use. And also avoid in high humidity, water and some other liquids.

Do not use the phone during thunderstorms.

CE

FCC

Disposal of the phone



This symbol indicates that the product is classified as electrical or electronic equipment and should not be disposed of with other commercial or household waste at the end of its working life.

Cleaning

To clean the device, use an anti-static cloth. Please avoid cleaning liquids as they might damage the surface or internal electronics of the phone.

Table of Content

Notices Information	1
Copyright	1
Safety cautions	1
Disposal of the phone.....	1
Cleaning	2
Table of Content	3
Getting Started.....	5
Packing List	5
Phone Installation.....	6
1. Attach the Foot stand	7
3. Connect the Network and Power.....	8
Initialization	8
Getting Familiar with Your Phone	10
Hardware Components Preview.....	10
Icon Preview	13
Memory Key Function Overview	14
Basic Features Configuration	16
Web Login	16
Administrator Password.....	17
Language.....	18
Time and Date.....	19
Screen Saver.....	22
Ring Tone.....	23
Volume.....	25
Directory	26
Basic Call Features.....	29
Place a Call	29
End a Call.....	30
Receive a Call	30
Auto Answer	31
Call Hold.....	32
Call Transfer	33
Call Conference.....	35
Call Forward	36
Call Return	39
Anonymous Call	40
Reject Anonymous.....	40
Call Mute	41
DND.....	42

Key as Send.....	42
No Key Entry Timeout.....	42
Keypad Lock.....	43
Hot Line	44
Advanced Features.....	45
Voice Message	45
Intercom	46
Speed Dial.....	47
Direct Pickup	48
Group Pickup	49
BLF	49
Shared Line	51
Record.....	52
Call Park.....	53
Paging	53
DTMF	54
Prefix.....	55
Upgrade	56
Factory Reset	56
Upgrade.....	56
Troubleshooting.....	59
Why is the phone LCD screen blank?.....	59
Why does the phone display "Network Unavailable"?	59
Why can't I get a dial tone?	59

Getting Started

Packing List

The package contains the following parts, please check if all the items are not missed:

The phone device

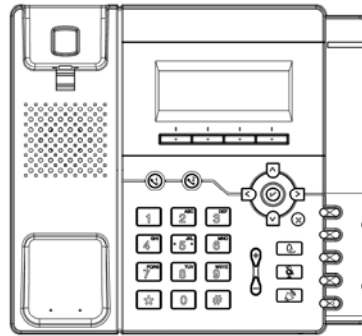

The footstand

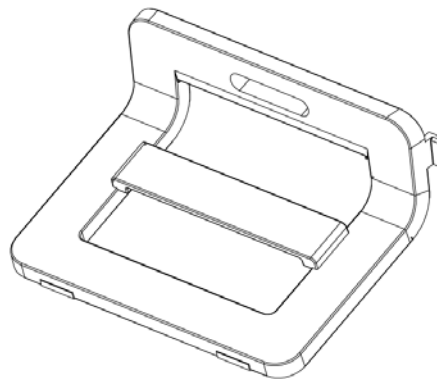

Handset



Headset cord

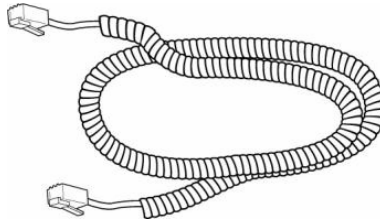

Power adapter

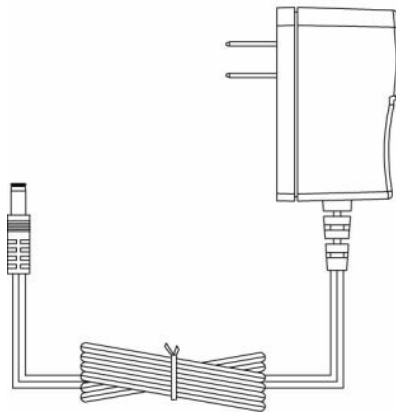

Ethernet cable

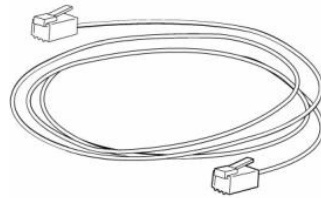

Quick installation reference



Phone Installation

1. Attach the Foot stand

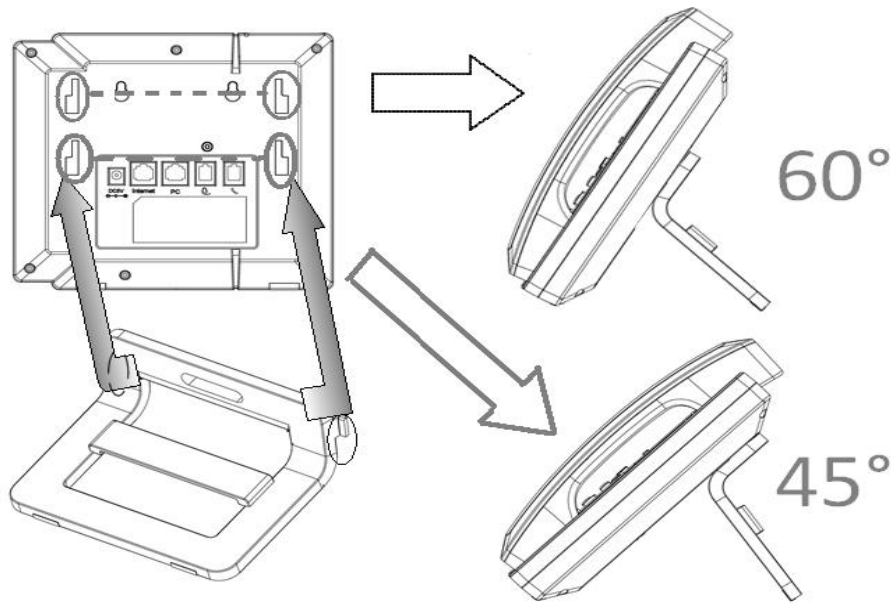

2. Connect the Handset and optional Headset

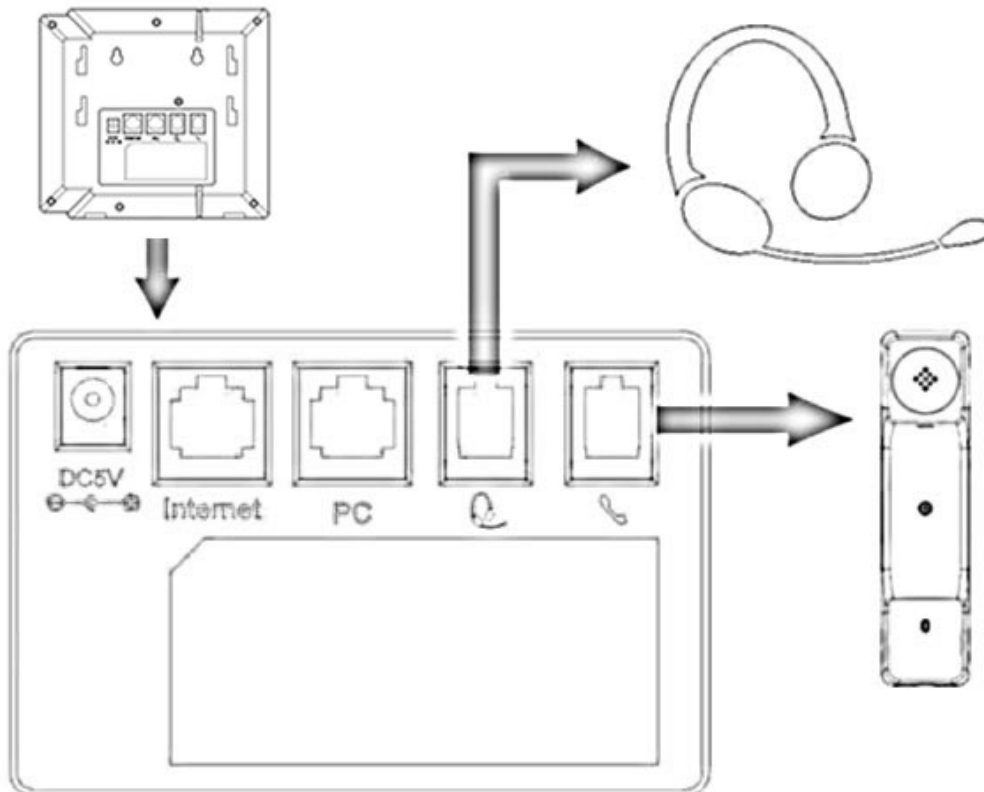

3. Connect the Network and Power

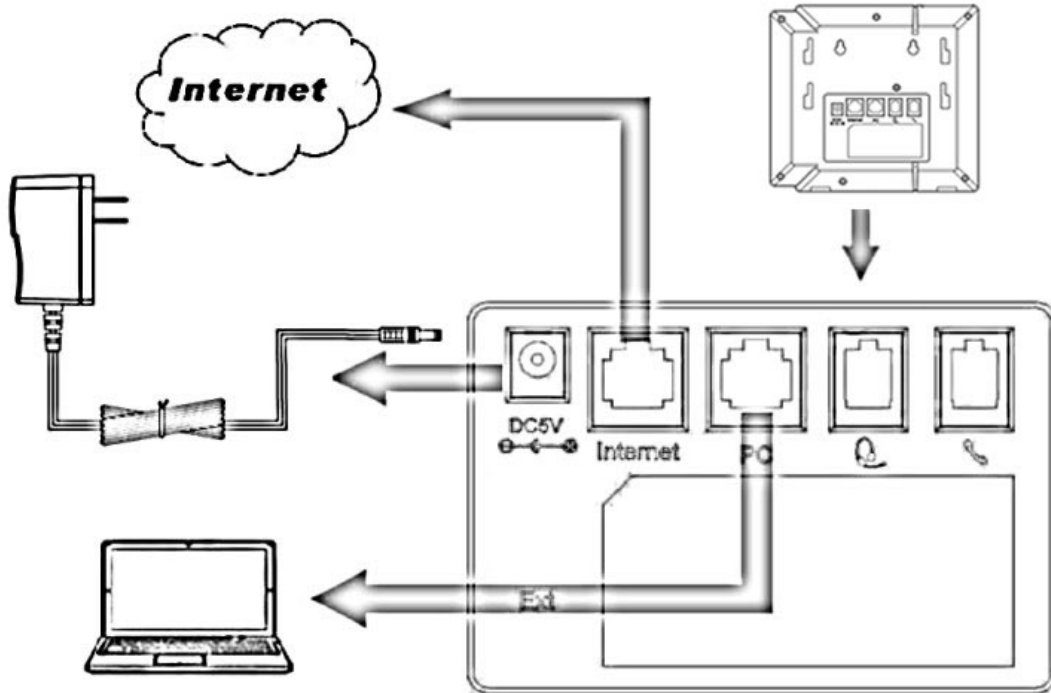

Initialization

After your phone has been powered up, the system boots up and performs the following steps:

Automatic Phone Initialization

The phone finishes the initialization process by loading the saved configuration. The phone LCD screen will display "Booting"

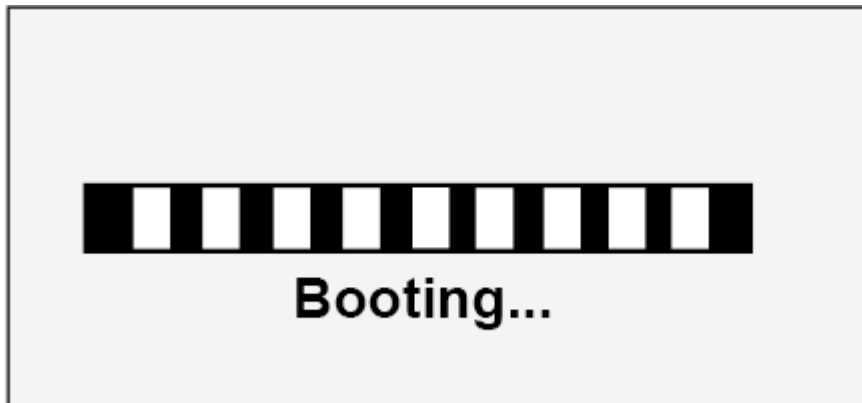

And then show “Initializing “during the initialization.







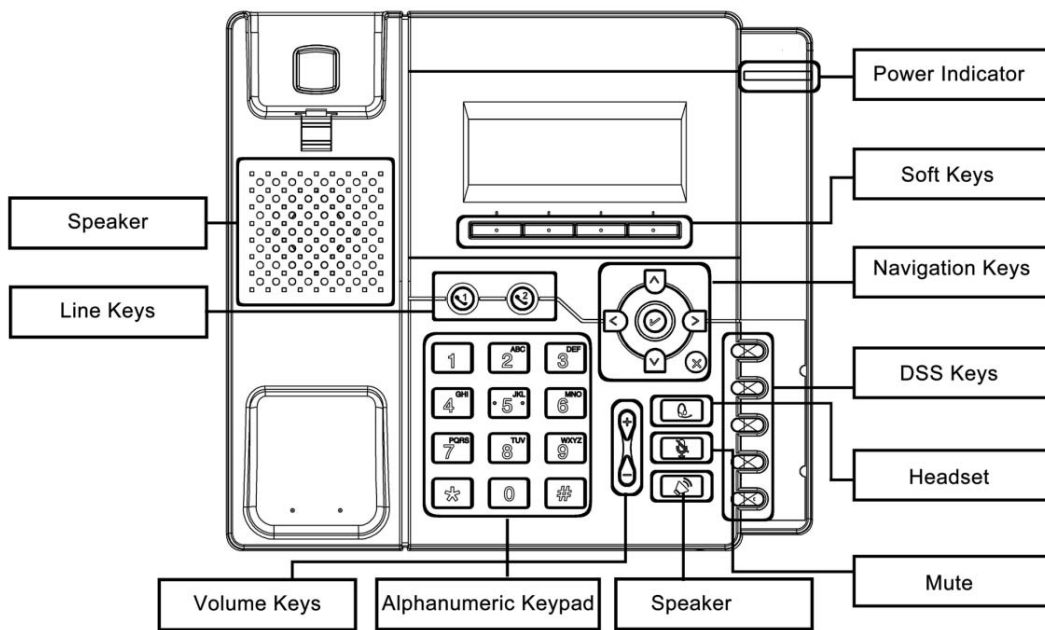

By default the phone attempts to contact a DHCP server in your network in order to obtain its valid network settings, e.g. IP address, subnet mask, default gateway, DNS server.





Getting Familiar with Your Phone

Hardware Components Preview















Item	Description
LCD screen	To Presentation all information about the date& time, accounts, soft keys, messages, calls and other some information.
Power Indicator LED	To indicate the power status
Line keys	The phone supported up to 4 accounts Steady green: idle interface, during a call.. Blink red: a call incoming
Soft keys	Labels automatically to identify their context-sensitive features.
Navigation keys	 1. OK.  Up arrow key: To move up of the selection shows on the screen.  Right arrow key: To move right of the selection shows on the screen.

	 Left arrow key: To move left of the selection shows on the screen.  Down arrow key: To move down of the selection shows on the screen.  <ol style="list-style-type: none"> 1. To return to idle screen. 2. To cancel the information or call on the screen.
Mute key	 <ol style="list-style-type: none"> 1. To mute the voice during the call (green light). 2. To un-mute the call.
Memory Keys	<p>To be configured as different function as:</p> <ul style="list-style-type: none"> Line Speed Dial BLF BLF List Voice mail Direct Pickup Group Pickup Call Park Intercom DTMF Prefix Hold Conference DND Redial Transfer SMS Hot -desking Call Return Paging Record Shared Line <p>The LED lights status when set as Shared line:</p> <ul style="list-style-type: none"> Stay green: Idle Stay red: Busy Blinked green: Ring Back Blinked red: A call incoming Steady orange: During a call Blinked orange: Public Hold Blinked green: Private Hold

	Light Drown: Unregistered
Speaker	 Press this button to place a call in hands-free mode.
Volume	 To decrease the volume.
	 To increase the volume.
Alphanumeric keypad	To enter the phone numbers, letters and so on.
Message	 To indicator the New message, and press to read.
Headset	 To indicate that the phone is or not in Headset mode.

Icon Preview

Icon	Description
	Network
	Registered succeed
	Unregistered
	Speakerphone mode
	Handset mode
	Headset mode
	Mute
	Forward
	Do Not Disturb
	Received calls
	Dialed Calls
	Missed calls
	Forward calls

Memory Key Function Overview

Line
Speed Dial
BLF
BLF List
Voice Mail
Direct Pick Up
Group Pick Up
Call Park
Intercom
DTMF
Prefix
Conference
Forward
Transfer
Hold
DND
Redial

Call Return
Record
URL Record
Paging
Group Listening
Public Hold
Private Hold
Shared Line
URL

Basic Features Configuration

This part will mainly introduce the basic configuration as the Time, Language, and Volume...

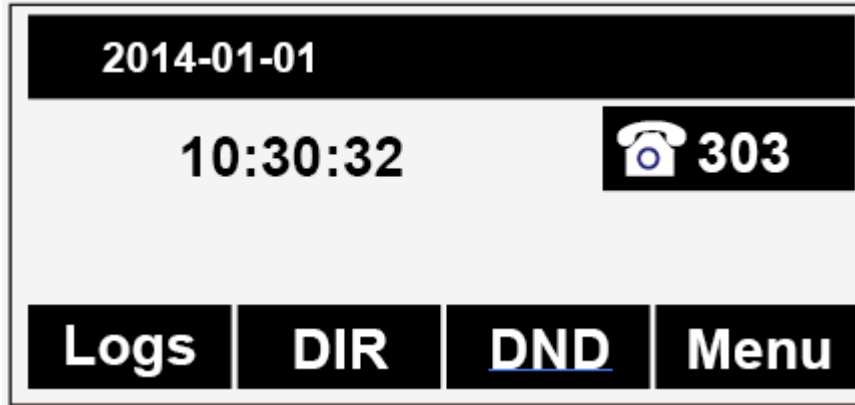

Web Login

Get the IP address: Press Menu → Status → Information

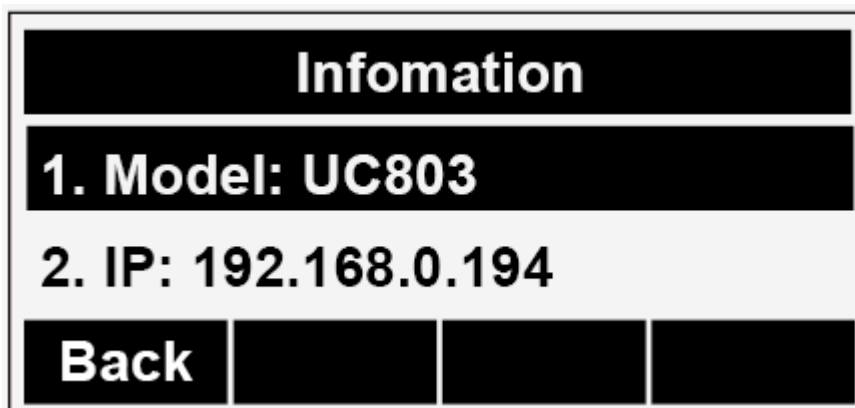

Input the IP Address in the web browser.

Input the user name (default is admin), password (default is admin).

Login successfully.

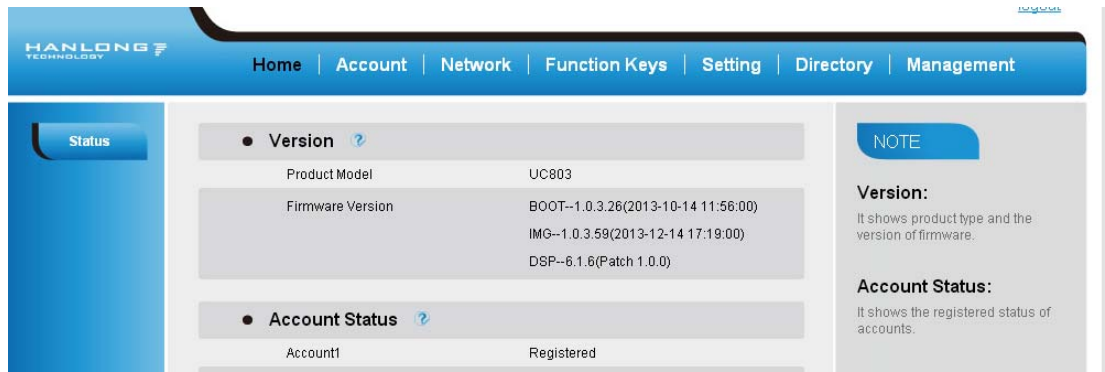

Note:

The PC and phone should be in the same segment.

When register the accounts in web and the server port is not “5060”, then “SIP Server” should be set as “SIP Server’s IP address: server port.”, for example, “192.168.0.122: 5090”.

Administrator Password

The password is mainly used for login the web interface or set the advanced settings through phone interface. And the default password of the administrator is: **admin**

To change to password via Phone Interface

Press Menu → setting → Advanced settings → password (default admin) → Phone Setting → Set Password

Enter the current PWD (password), new password and confirm the new password.

Press save soft key or  to save the new password.

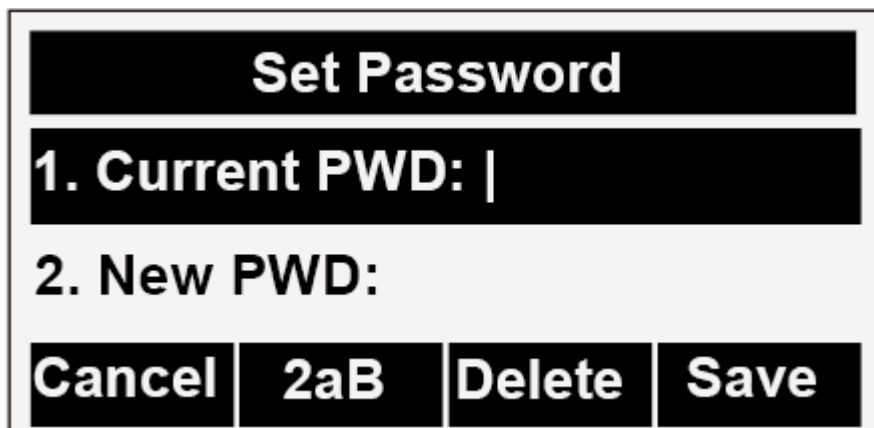

To change to password via Web Interface

Management → Password

Fill the value

Click  to save the configuration.

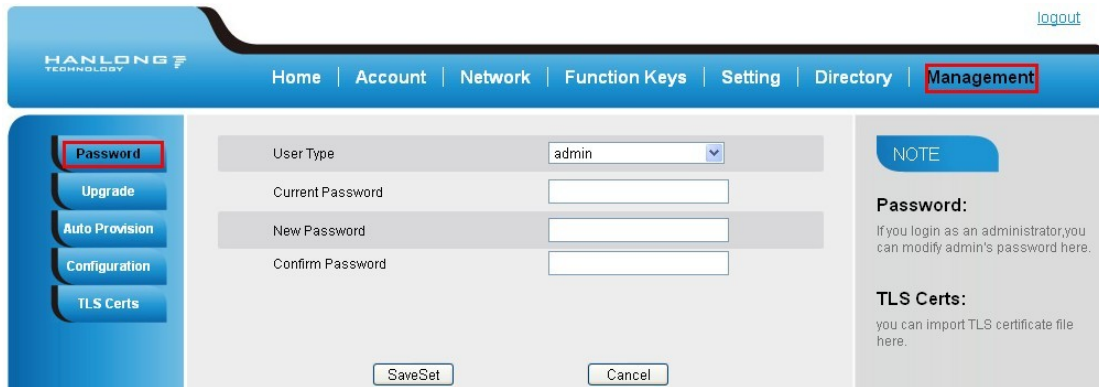

Note:

When you use the web interface: user name: admin password: admin(default)

Language

The default Phone interface language is English.

To change the language via Phone interface

Press Menu → Setting → Basic Settings → Language.

Press  or Save soft key to save the configuration.



To change the language via Web Interface

Setting → Preference → Web Language

Select the necessary one.

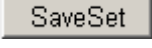
Press  to save the configuration.

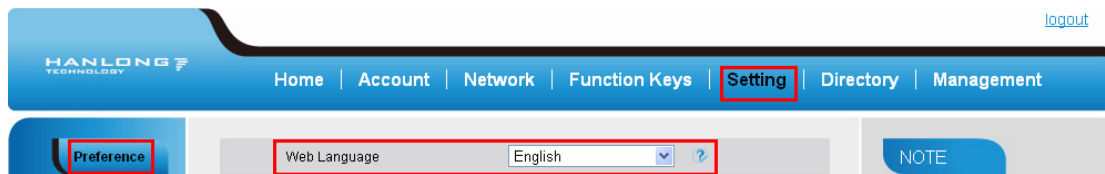

Note:



All languages may not be available for selection. The available languages depend on the language packs currently loaded to the IP phone.

Time and Date

The time and date show on the idle page, and it can be set and change by SNTP server automatically or manual setting.

To configure the time and Date by SNTP setting

To press Menu → Setting → Basic setting → Time & Date → SNTP Settings

Press  or , or Info soft key to change the Time zone.

Fill the NTP server1, NTP Server2, and Daylight Saving.

Press  or Save soft key to save the configuration.





Note:

Press , all zone will show on the display, select the one you want and press save or confirm key to save the configuration.

To configure time and date manually



To press Menu → Setting → Basic setting → Time & Date → Manual Settings



Press  and  or change the right time, or you can input the right time.

Press  or Save soft key to save the configuration.

To configure the Time & Date Format

To press Menu → Setting → Basic setting → Time & Date Format



Press  and  or press Info to change between 12 Hour or 24 Hour.

Press  and  or press Info to change among Y-M-D(year-month-day), M-D-Y(month-day-year), D-M-Y(day-month-year).

Press  or Save soft key to save the configuration.

To configure the DHCP time

To press Menu → Setting → Basic setting → DHCP time

Press  and  or press Info to change between Disable and Enable.

Press  or Save soft key to save the configuration.

To configure the Time and Date by web interface

Login

Login name: admin, password: admin(default)

Network → Advanced → NTP Server

Fill the value in the blank.

Logout

HANLONG TECHNOLOGY

Home | Account | **Network** | Function Keys | Setting | Directory | Management

Basic

Advanced

- LLDAP
 - Active: Disable
 - Packed Interval: 120 (1~3600s)
- Qos Set
 - Layer 3 Qos: 48
 - Layer 2 Qos: 802.1Q/VLAN Tag 0
 - Layer 2 Qos: 802.1p priority value 0
 - Data VLAN Tag: 0
- **NTP Server**
 - URI or IP address: time.windows.com
 - Override MTU Size:
 - Allow DHCP Option 42 To Override NTP Server: No Yes

NOTE

QoS:
When the network capacity is insufficient, QoS could provide priority to users by setting the value.

NTP Server
The server which is used to synchronize the clock of the phone.

To change the Time Zone and Date Display Format via web interface

Setting → Preference → Time Zone

Select the necessary one.

Press **SaveSet** to save the configuration.

Logout

HANLONG TECHNOLOGY

Home | Account | Network | Function Keys | **Setting** | Directory | Management

Preference

Features

Ring

Tones

SMS

Web Language: English

- Time Zone:** GMT+8:00 (Beijing, Singapore, Taipei, ...)
- DHCP Time: No Yes
- Daylight Saving Time: No Yes
- Date Display Format:** Year - Month - Day Month - Day - Year Day - Month - Year
- Lock Keypad Update: No Yes
- Keypad DTMF Tone: On Off
- MIC Volume Amplification: 0dB default

SaveSet Cancel

NOTE

Time Zone:
Choose the time zone you are in.

Note:



If the IP Phone cannot obtain the time and date from the Simple Network Time Protocol (SNTP) server, please contact your system administrator for more information.

Screen Saver

There are two types of screen saver: Backlight off, Time & Logo .

To enable screen saver via Phone

To press Menu → Display → Screensaver...



Press  and  or press Switch soft key to Choose the Time-out as 1 min or 2/5/10/30 minute.

Enter the Screensaver Type to choose one of the type: Backlight off, Time & Logo.

Press  or Save soft key to save the selected configuration.

To disable screen saver via Phone

To press Menu → Display → Screensaver...

Press  and  or press Switch soft key to Choose the Time-out as off.

Press  or Save soft key to save the selected configuration.

To Enable screen saver via Webpage

To Click Setting → Preference

To choose the Time-out as 1 min or 2/5/10/30 minute.

To select the screen Type as Backlight off or time & logo.

Click Saveset to save the configuration.

To Disable screen saver via Webpage

To Click Setting → Preference

To choose the Time-out as Off

Click Saveset to save the configuration.

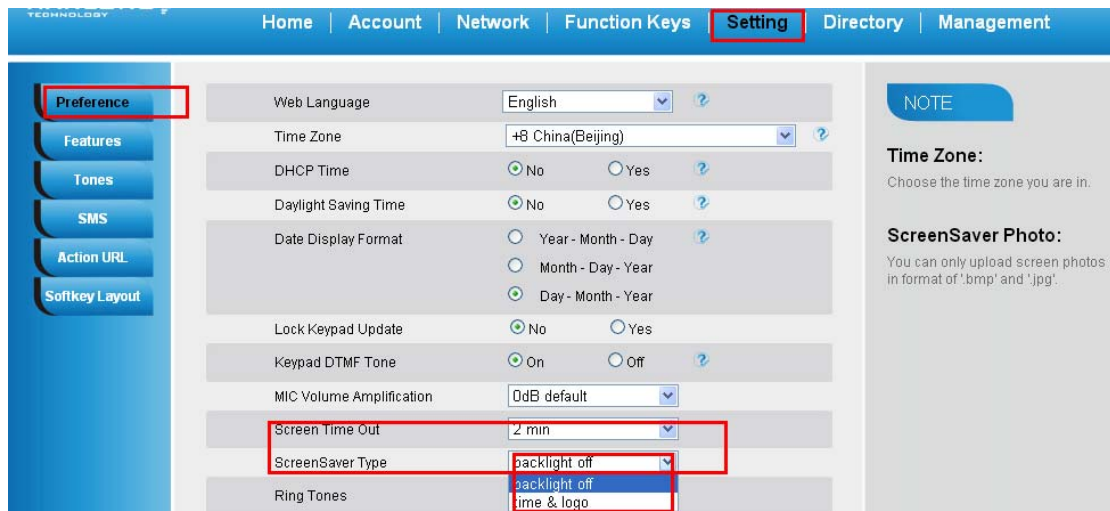

Ring Tone

You can adjust the type and volume of the ring tone.

To adjust the Ring Tone Type via Phone interface

Press Menu → Setting → Basic Settings → Ring Tone.

Press and to select the aimed one.

Press or Save soft key to save the configuration.

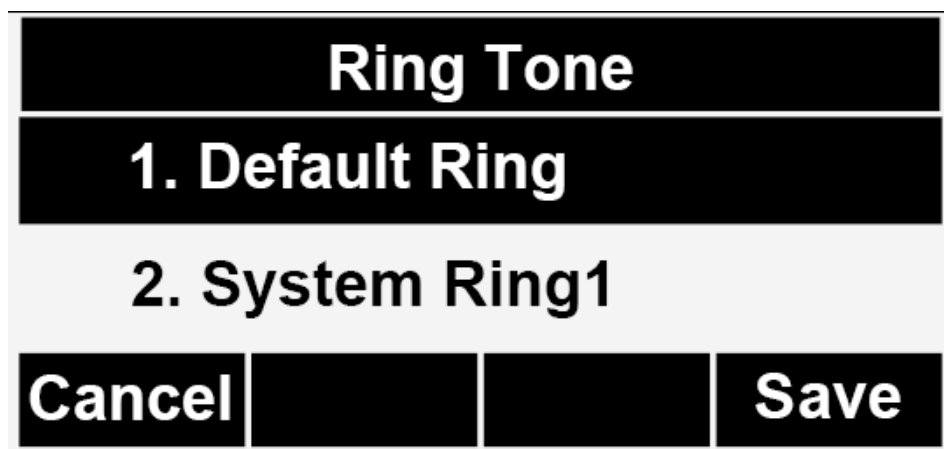

To adjust the Ring Tone Type via Web Interface

Account → Advanced → Account Ring Tone

Select the wanted one

Click  to save the configuration.

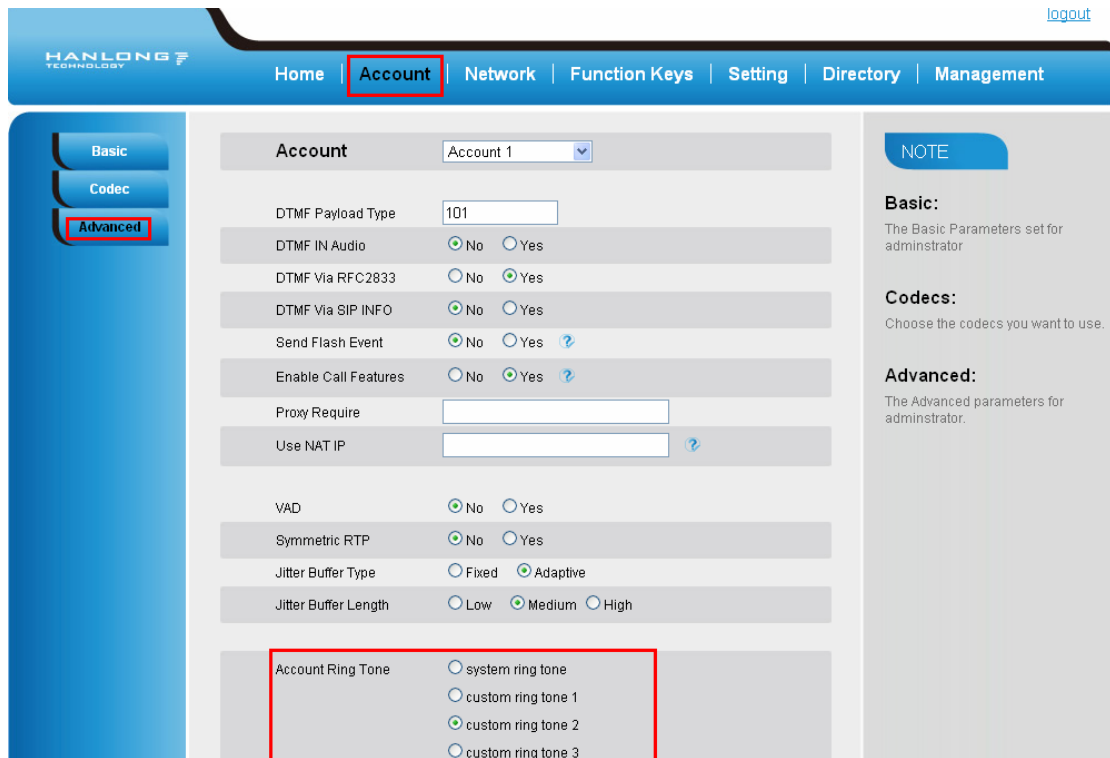



To configure Distinctive Ring Tone via Phone Interface

Press Directory



Select the target contact

Press Detail soft key to edit the contact.



Press  and  to select the wanted Ring Tone for the contact

Press Save soft key to save the contact.



Volume

You can adjust the volume for the phone by the volume keys:  and .

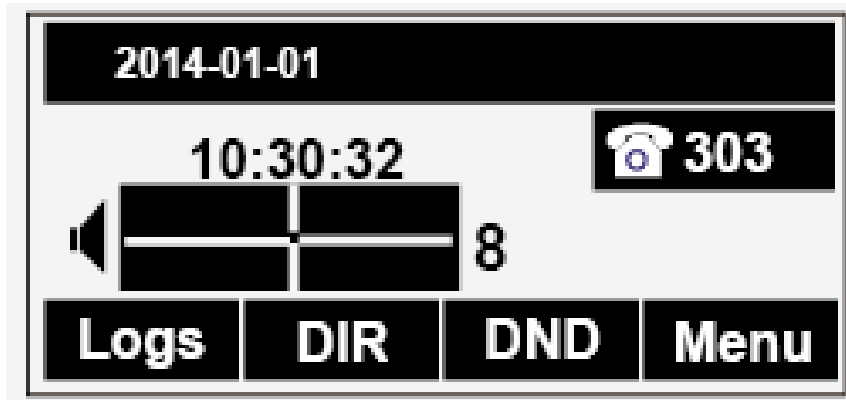

To adjust the Ring tone volume

Option 1: To press  and  on the idle page





Option 2: To press  and  during the call is ringing.

To adjust the handset volume

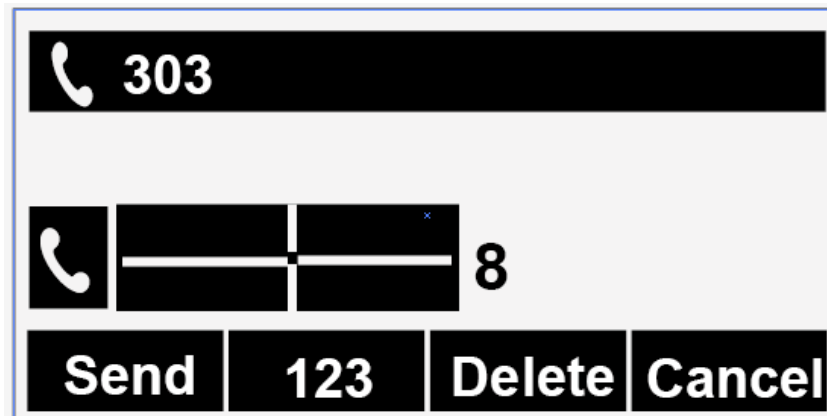
To press  and  during a call in handset mode.



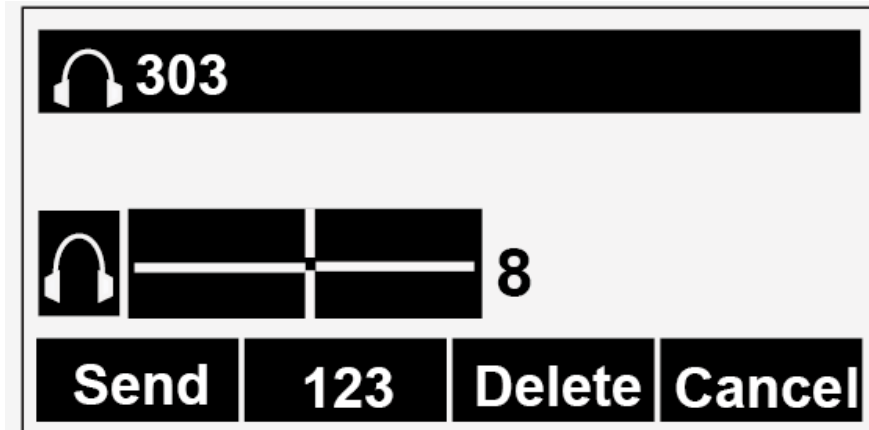

To adjust the headset volume

To press  and  during a call in headset mode.



To adjust the speaker Volume

To press  and  during a call in speaker mode.

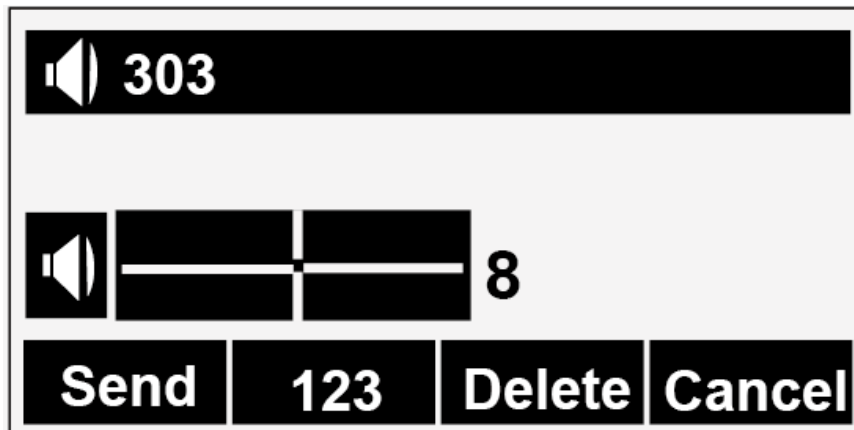

Directory

In the directory, you can add or delete your friends, business partner or anyone others' phone No. so you will not forget their number. Or put some anonymous phone No. in the blacklist to prevent from being disturbed.

A. To add contacts list into local directory

To add contacts manually

Press Menu → DIR

Press Add soft key





Add Contacts			
1. Name:			
2. Number:			
Cancel	2aB	Delete	Save

Enter the necessary information as Name, Phone number...

Press save soft key or  to add the contacts successfully.

To add contacts from Logs

Press History soft key or press Menu → Logs → Local history

Press  and  to select the targeted one. (Press  and  switched among the All calls, Dialed calls, Received calls, Missed Calls and Forward Calls).

Press Option soft key → Add to Contacts

Edit the necessary information as Name, Phone number...

Press save soft key or  to add the contacts successfully.

To add contacts via web interface

Click Directory

Enter the name, number and some other information.

Press  and then press  button.

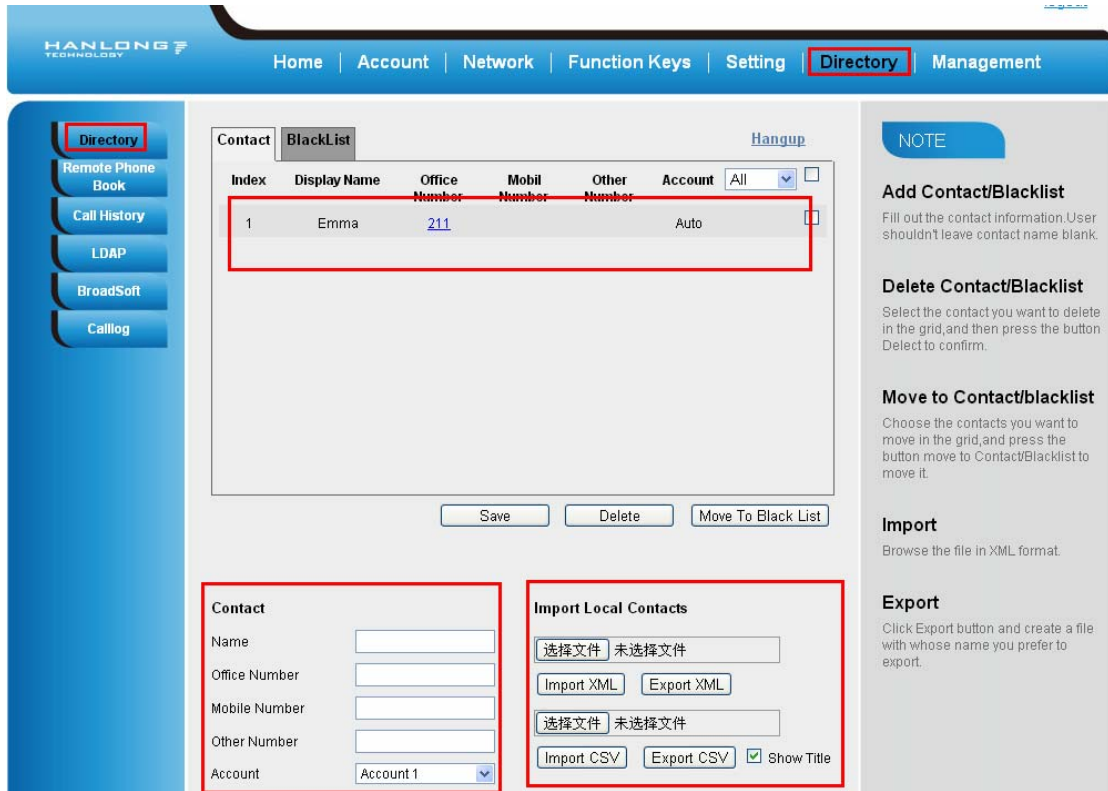

B: To add contacts into blacklist

To add blacklist manually

Press Menu → Directory → Blacklist



Press Add soft key.

Enter the necessary information as Name, Phone number...

Press save soft key or  to add the contacts successfully.

To add blacklist from history

Press History soft key or press Menu → History → Local history

Press  and  to select the targeted one.

Press Option soft key → Add to Blacklist

Edit the necessary information as Name, Phone number...

Press save soft key or  to add successfully.

Basic Call Features

Place a Call

There are three ways to dialing a call: Handset, Headset and Hands-free speakerphone.

To place a call by Handset

Pick up the handset, or press a line key and dial the necessary number.

Press  or press the send softkey, then the call is sending.

To place a call by Headset:

Press the  (light is Green),

Enter the desired number.

Press  or press the Send softkey, then the call is sending.



Placing a call by hands-free speakerphone

Press the , or press the Line key, then you can hear the dial tone.
Press the number.

Press  or press the Send soft key, then the call is sending.

To place a call by call history or Directory

Press the History soft key (On the idle page) or Menu → History /Directory

Press  and  to select the targeted one.

Press Send soft key to make the call.

Note:

The  key is set to be a send key. You can set the * key as send key or set some other to be as send keys. For more information, refer to the Key as Send on page
During the call, you can also change among Headset, Handset or Free-speaker mode.

End a Call

Here shows to end a call during three mode:

To end a call by Handset

Press the Cancel soft key or hang up the handset.

To end a call under Headset Mode

Press the Cancel soft key or press .

To end a call under hands-free speakerphone Mode

Press the Cancel soft key or press .

Note:

During the conference, to end the call is same as mentioned above.

Receive a Call

There are three ways to receive a call when the phone is ringing:

To receive a call by handset

Pick up the handset the conversation is built.

To receive a call by headset

Press  and now the conversation is built.

To receive a call by hands-free speaker

Option 1: Press  directly.

Option 2: Press Answer soft key.

Option 3: Press the Line key (flashes red).

Moreover, some other action can be done by soft key when the call is coming.

To press the Reject soft key to reject the call. Or press  to reject the current call.

To press Forward to forward to another phone.

To press Silence soft key, and then the call will keep silent, no ring tone display.

Auto Answer

Enable auto answer feature, you will answer all incoming call automatically.

To enable Auto Answer via Webpage

To Click Account → Advanced

To choose Yes for the Auto Answer.

To click Saveset to save the configuration.

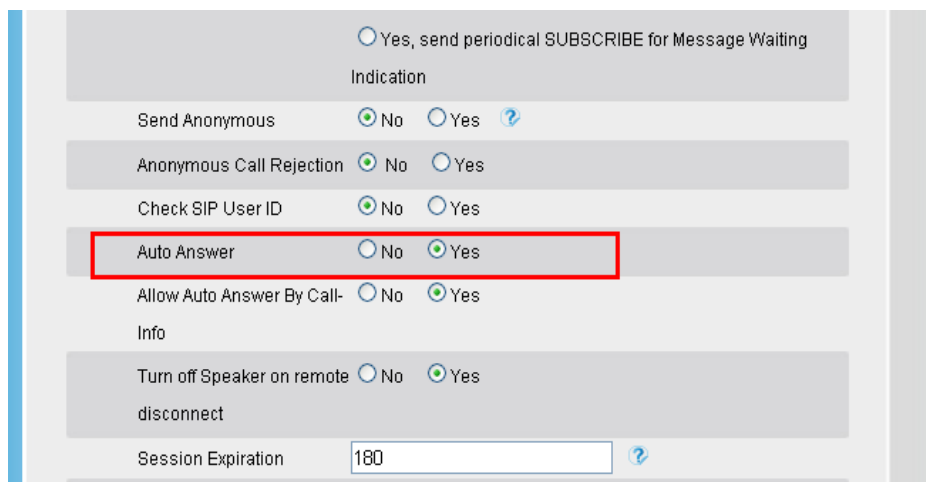

The screenshot shows a configuration page with several settings. The 'Auto Answer' setting is highlighted with a red box and is set to 'Yes'. Other settings include 'Send Anonymous' (No), 'Anonymous Call Rejection' (No), 'Check SIP User ID' (No), 'Allow Auto Answer By Call-' (Yes), 'Turn off Speaker on remote disconnect' (Yes), and 'Session Expiration' (180).

Indication	<input type="radio"/> Yes, send periodical SUBSCRIBE for Message Waiting
Send Anonymous	<input checked="" type="radio"/> No <input type="radio"/> Yes ?
Anonymous Call Rejection	<input checked="" type="radio"/> No <input type="radio"/> Yes
Check SIP User ID	<input checked="" type="radio"/> No <input type="radio"/> Yes
Auto Answer	<input type="radio"/> No <input checked="" type="radio"/> Yes
Allow Auto Answer By Call-	<input type="radio"/> No <input checked="" type="radio"/> Yes
Info	
Turn off Speaker on remote disconnect	<input type="radio"/> No <input checked="" type="radio"/> Yes
Session Expiration	<input type="text" value="180"/> ?

To Disable Auto Answer via Webpage

To Click Account → Advanced

To choose No for the Auto Answer.

To click Saveset to save the configuration.

Call Hold

When use hold feature, the Hold icon will show on the display.

To make a call on hold during three modes:

To hold a call under handset mode:

Press Hold soft key to hold the current call.



Press Resume soft key to resume the call on hold.



To hold a call under headset mode:

Press Hold soft key to hold the current call.

Press Resume soft key to resume the call on hold.

To hold a call during the speaker mode:

Press Hold soft key to hold the current call.

Press Resume soft key to resume the call on hold.

Call Transfer

This phone supports blind, attended and Semi-Attended Transfer.

Blind Transfer

When you use this feature, you can transfer

Press Transfer soft key during the conversation, the call is on hold now.

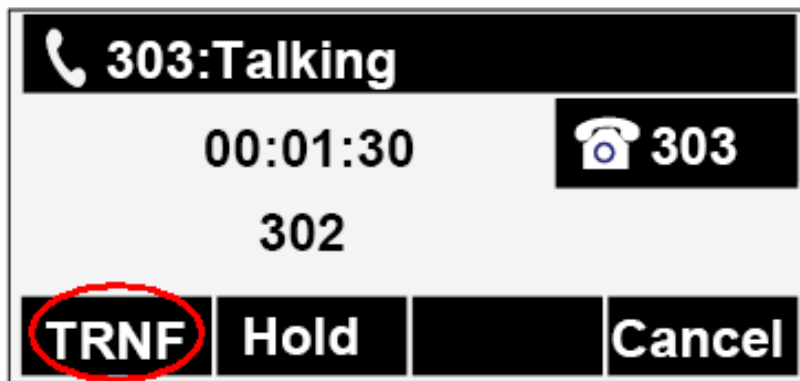

Enter the number that transfers to.



Press Transfer soft key , and now the blind transfer completed.

NOTE:

The “Enable Call Feature” must be configured to “Yes” to enable this feature.

Attended Transfer

When you use this feature, you can

Press transfer soft key during the conversation, the call is on hold now.

Enter the number that transfer to, and press the send soft key or .

Start the second conversation, press the transfer soft key, then, transfer completed.

NOTE:

To transfer calls across SIP domains, SIP service providers must support transfer across SIP domains. Blind transfer will usually use the primary account SIP profile. To use this function, should at least one line key set as Auto.

Semi-Attended Transfer

Press the transfer soft key during the conversation, the call is on hold now.

Enter the number transfer to, and then press , then you can here the ring tone.

Press the Transfer soft key, and now the Semi-attended transfer completed.

NOTE: To use this function, should at least one line key set as Auto.

BLF Transfer

Set a Programmable Key or line key is set as BLF. For how to set BLF, please refer to [BLF](#)

Press the transfer soft key during the conversation, the call is on hold now.

Press BLF key then realize blind, attended and Semi-Attended Transfer.
(Webpage--Setting--Features)

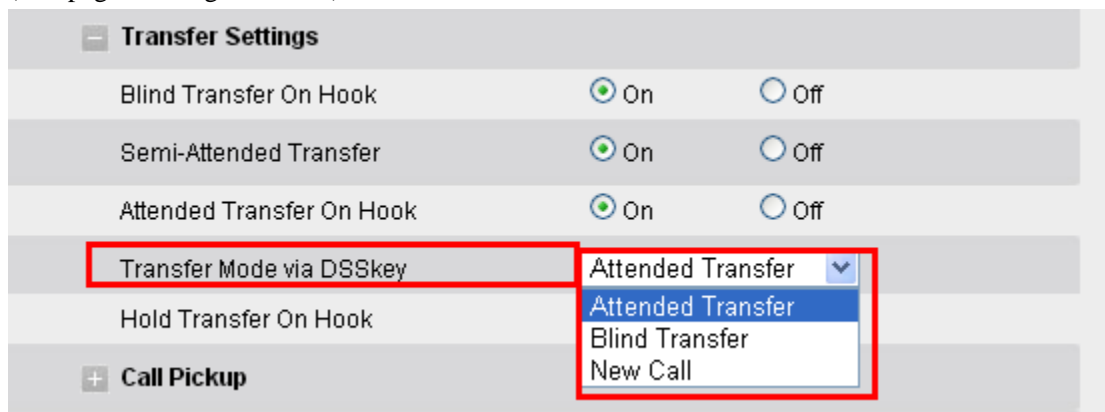

Call Conference

This IP Phone supports up to 5-way conference.

5-way conference

Assuming that call party A and B are in conversation. A wants to bring C, D and E in a conference

A press line 2 key, the call is placed on hold.

A enter the number of C and then press send soft key or .

C answering the call.

A press conference soft key, then A, B and C are now in a conference.(and now this is **3-way conference**)



A press line 3 key, the current 3-way conference is placed on hold.

A enter the number of D and then press send soft key or .

D answering the call.

A press the conference soft key, then A, B, C and D are now in a conference.(and now this is **4-way conference**)

A press line 4 key, the call is placed on hold.

A enter the number of E and then press send soft key or .

E answering the call.

A press the conference soft key, then A, B, C, D and E are now the **5-way conference** is built.

A end the call, the conference is finished.

Note:

If C does not answer the call, A can back to continue the conversation with B;

Once A hangs up the call, the conference is ended, while if B or C drops the call, A&C or A&B conversation continues.

The conference feature is not available on all servers. For more information, contact your system administrator.

To realize the 5 way conference, the line should be all available.

Call Forward



This phone supports static forward (always forward, busy forward and no answer forward) and dynamic forward

To configure static forward

To configure always forward

With this feature, all incoming calls will forward immediately to configured number.

Press Menu → Features → Call forward → Always Forward.

Press  and  or press info soft key to select the enable choice



Enter the forward to number and on code (optional), off code (optional).



Press  or Save soft key to save the configuration.



To configure busy forward

With this feature, the incoming calls are immediately forwarded if the phone is busy.

Press Menu → Features → Call forward → Busy forward.

Press  and  or press info soft key to select the enable choice.



Enter the forward to number and on code (optional), off code (optional).

Press  or Save soft key to save the configuration.

To configure no answer forward

No Answer Forward: Incoming calls are forwarded if not answered after some time.

Press Menu → Features → Call forward → No answer forward.

Press  and  or press info soft key to select the enable choice

Enter the forward to number and on code (optional), off code (optional).

Press  or Save soft key to save the configuration.

When the Forward feature is enabled, the Forward Icon will display on Top of the LCD.

To configure Forward via Web Interface

Setting → Features

Click On for the Always/Busy/No Answer

Fill the Forward to Number

(Optional) fill the on/off code

Click **SaveSet** to save the configuration

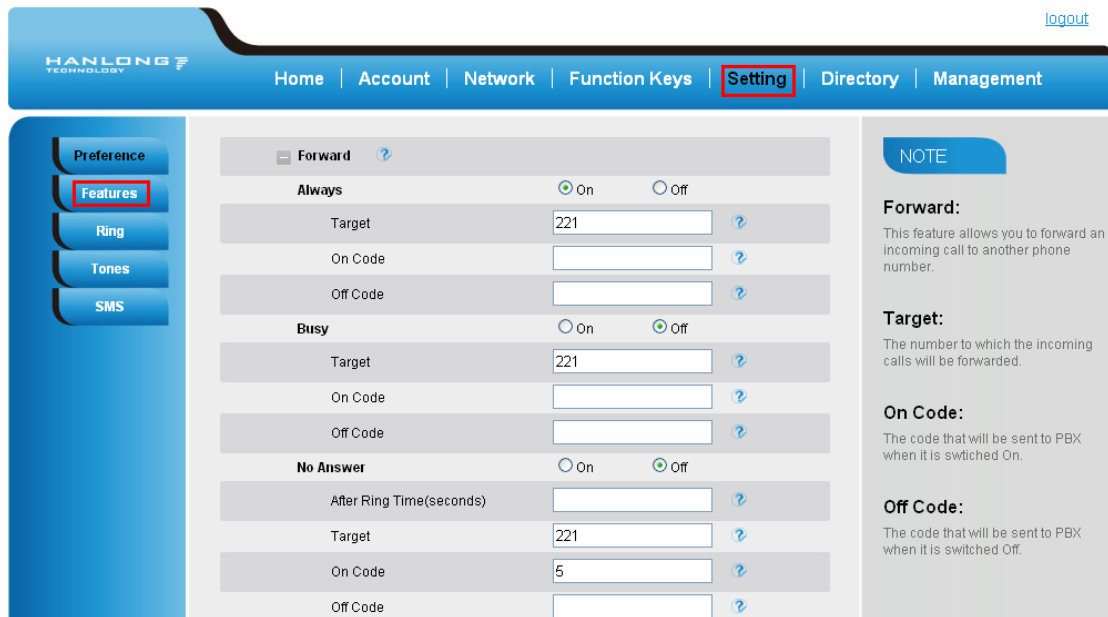

To cancel the forward feature via Phone Interface

Press Menu → Features → Call forward → Always/Busy/No answer Forward

Press and or press info soft key to select the disable choice

Press or Save soft key to save the configuration.

To cancel the forward feature via Web Interface

Setting → Features

Click Off for the Always/Busy/No Answer

Click **SaveSet** to save the configuration

To configure dynamic forward

Forward an incoming call during the ringing.

When the phone is ringing, press Forward soft key.



Enter the forward number.

Press  or press the send soft key, then the call is forwarded.

Note:
If the Programmable Key or line key is set as BLF, when an incoming call ringing, press this BLF key directly to realize the dynamic forward.



Call Return



This feature allows you to dial the last phone call you received.

To configure the Call Return via phone interface

Press Menu → Features → Function Keys → Line or Memory keys as Function Keys → Memory key1 (for example)

Select the wanted Line or Memory key.

Press  and  or press info soft key to select the Key Event in the type field.

Press  and  or press info soft key to select the Call Return.

Press  or Save soft key to save the configuration

To configure the Call Return via Web interface

Click Function keys → Line or Memory key.

Select the desired Line or Memory key and select Call Return in the Type.

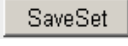

Click the  to save the configuration.



Anonymous Call

Just enable the anonymous call feature, you can set your ID do not appear on the other phone that you called.

To configure anonymous call

Press Menu → Features → Anonymous Call

Press  and  or press info soft key to change the Line ID



Press  and  or press info soft key to select the enable choice in Anonymous Call filed.

Enter the call on code (optional), call off code (optional).

Press  or Save soft key to save the configuration.

To cancel anonymous call feature

Press Menu → Features → Anonymous Call

Press  and  or press info soft key to select the disable choice in Anonymous Call filed.

Press  or Save soft key to save the configuration.

Reject Anonymous

If you do not want to be disturb by anonymous calls, you can set the reject anonymous call features, so you will not hear the unknown calls

To configure rejecting anonymous call

Press Menu → Features → Anonymous Call

Press and or press info soft key to change the Line ID

Press and or press info soft key to select the enable choice in Rejection filed.

Press or Save soft key to save the configuration

To cancel rejecting anonymous call

Press Menu →Features →Anonymous Call

Press and or press info soft key to select the disable choice in Rejection filed.

Press or Save soft key to save the configuration.

Call Mute

When you use the Mute feature, the other parties will not hear your voice while you can hear their voice. Call mute applies to all modes (handset, headset, and speakerphone).

To mute the call during a call (including a conference call)

Press the mute key , then the mute key glows green, and the LCD display Mute Icon.



To disable the mute function, press again.

DND

When you use the DND feature, the phone is to reject all incoming calls automatically and you can see the DND icon shown on the Top of the LCD on idle page.

To enable DND feature

Press the DND soft key when the phone is idle, and then DND icon shown on the LCD.



To disable DND feature

Press the DND soft key again, and then there is no DND icon on the LCD.

Key as Send

To configure Key as Send

Press Menu → Features → Key as Send

Press  and  or press info/switch soft key to select the enable choice.

Press  or Save soft key to save the configuration

To cancel # Key as Send

Press Menu → Features → Key as Send

Press  and  or press info/switch soft key to select the disable choice.

Press  or Save soft key to save the configuration.

No Key Entry Timeout

No Key Entry Timeout means that when you enter the number, it will dial out automatically after some time when you stop enter the number.

To configure No Key Entry Timeout

Click Webpage Setting → Preference

Fill the blank of No Key Entry Timeout: for example 5(seconds).(0 means never timeout, you should press the send key the dial out the number.

3. Click the  to save the configuration.

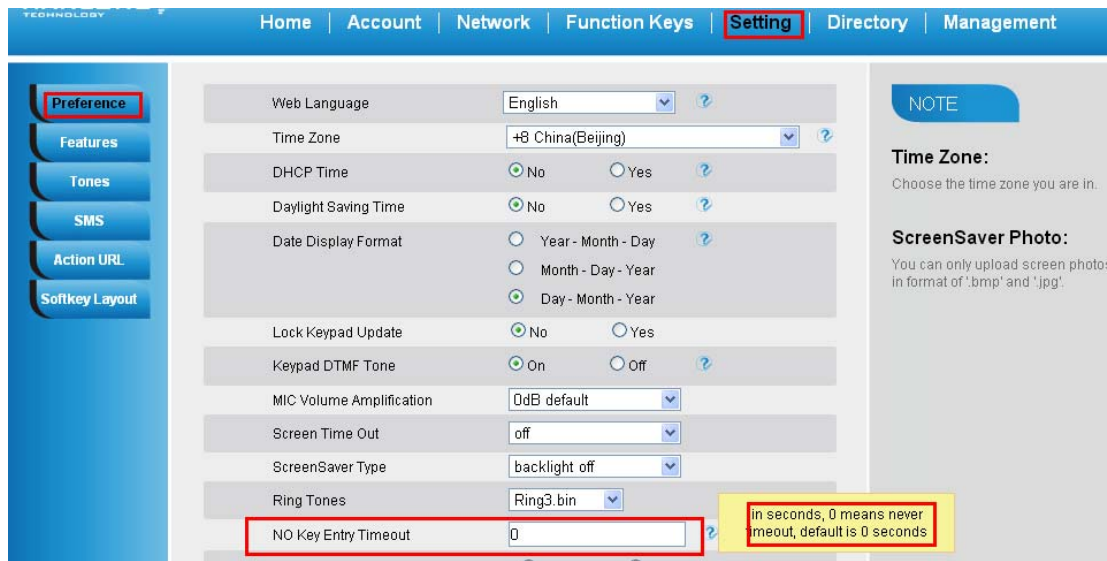

Keypad Lock

To enable Keypad Lock via Phone

1. Press Menu--Settings--Advanced Setting--Phone Setting--Lock
2. Press Info or Switch to change choose lock type:All Keys Menu Key Function Key Lock & Answer
3. Press Save or OK key to save the configuration.

To enable Keypad Lock via Phone

Press Menu--Settings--Advanced Setting--Phone Setting--Lock

Press Info or Switch to change choose Off.

Press Save or OK key to save the configuration.

To enable Keypad Lock via Webpage

Click Webpage Setting → Preference

To choose the Lock keys.

To fill the unlock PIN and auto lock time

Fill the Emergency Number, when the phone is Lock, only Emergency Number can be sent.

To click Saveset to save the configuration.

Phone Lock	
Keypad Lock	Function Keys
Phone Unlock Pin(0~15digital)
Auto Lock Time-Out(0~3600s)	60
Emergency	

To Disable Keypad Lock via Webpage

1. Click Webpage Setting → Preference

2. To choose Disable for the Phone Lock.

3. To click Saveset to save the configuration.

Hot Line

To configure Hot Line

Press Menu → Features → Hot Line

Enter the Number and delay time (as present, we support off hook auto dial).

Press  or Save soft key to save the configuration

To configure Hotline auto dial via Web Interface

Setting → Features.

Fill the number in the Hotline Number and Hotline Time-out.

Click **SaveSet** to save the configuration.

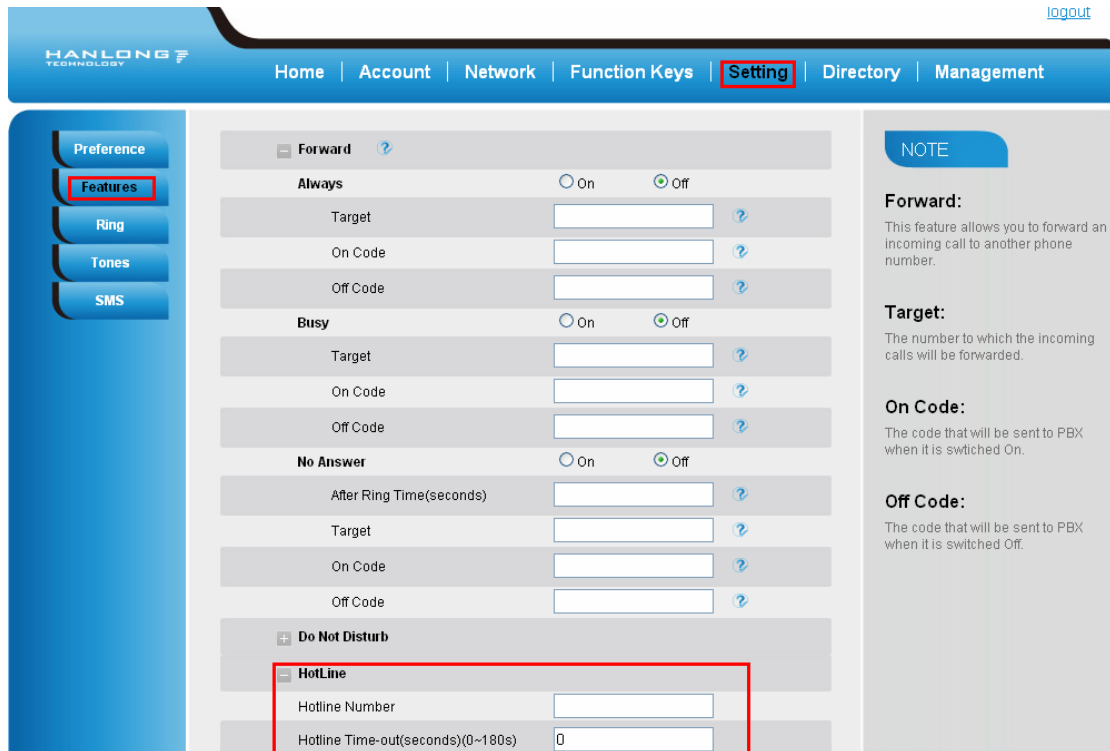

Delete the number and save the configuration, and then now the Hotline auto dial is cancelled.

Advanced Features

Voice Message

This phone supports Voicemail, and when there is message, the message will  will light green. Moreover, when pick up the handset, or press speaker key, you will hear some quick busy tone.

To configure the Voice mail feature

Press Menu → Messages → Voice Mail → Set Voice Mail.

Enter the Account1/2/3/4 NO.

Press  or Save soft key to save the configuration

Note:



This feature is not available on all servers. For more information, contact your system administrator.

Intercom

When use the intercom feature, you can quickly get access connect to the configured one.

To configure intercom feature via phone interface

Press Menu → Features → Function Keys → Line or Memory keys as Function Keys → Memory key1(for example)

Press  and  or press info soft key to select the intercom in the type field.

Enter the targeted Number.

Press  or Save soft key to save the configuration

Then the selected Line or Memory key will work as intercom.

To configure Intercom feature via Web Interface

Click Function keys → Line or Memory key.

Select the wanted Line or Memory key.

Enter the desired phone number in the Value field.

Select the Account ID

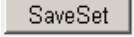
Click the  to save the configuration.

Key	Type	Value	Account	Pickup Code
Memory Key1	Intercom	*80222	Account 1	
Memory Key2	Line		Account 1	
Memory Key3	Line		Account 1	
Memory Key4	Line		Account 1	
Memory Key5	Line		Account 1	

NOTE

Key Type:
The free function key Type Speed Dial, BLF, Key Event, intercom, URL...

BLF:
BLF setting require a phone restart

Note:



This feature is not available on all servers. For more information, contact your system administrator.

Speed Dial

With this feature, you can dial one directory by press the definite key.

To configure Speed Dial feature via phone interface

Press Menu → Features → Function Keys → Line or Memory keys as Function Keys → Memory key1 (for example)

Press  and  or press info soft key to select the Speed Dial in the type field.

Enter the targeted Number.

Press  or Save soft key to save the configuration

Then the selected Line or Memory key will work as Speed Dial.

To configure Speed Dial feature via Web Interface

Click Function keys → Line or Memory key.

Select the wanted Line or Memory key and set as Speed Dial.

Enter the desired phone number in the Value field.

Select the Account ID

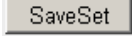

Click the  to save the configuration.

Direct Pickup

With this feature, you can pick up the set line when it ringing.

To configure Direct Pickup feature via phone interface

Press Menu → Features → Function Keys → Line or Memory keys as Function Keys → Memory key1 (for example)

Press  and  or press  key to select the Speed Dial in the type field.

Enter the value.

Press  or Save soft key to save the configuration

Then the selected Line or Memory key will work as Direct Pickup.

To configure Direct Pickup feature via Web Interface

Click Function keys → Line or Memory key.

Select the wanted Line or Memory key and set as Direct Pickup.

Enter the pickup code and followed the desired phone number in the Value field.

Select the Account ID

Click the  to save the configuration.



Group Pickup

With this feature, you can pick up the specified group that you want incoming calls.

To configure the Pick up via phone interface

Press Menu → Features → Function Keys → Line or Memory keys as Function Keys → Memory key1 (for example)

Select the wanted Line or Memory key.

Press  and  or press info soft key to select the Group Pickup in the type field.

Enter pickup code and followed the desired group number

Press  or Save soft key to save the configuration

To configure the Group Pick up via Web interface

Click Function keys → Line or Memory key.

Select the desired Line or Memory key and select Group Pickup in the Type.

Enter the pickup code and followed the desired Group number in the Value field.

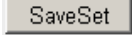
Click the  to save the configuration.

BLF

You can use the BLF (Busy Lamp Field) feature to monitor a specific one whether his phone is busy or free.

When the monitored line is idle, the light is steady green.

When the monitored line is ringing, the light is blinking red, press the BLF key to pick the phone up directly.

When the monitored line is calling or in a conversation, the light is steady red.

To configure a BLF key by phone

Press Menu → Features → Function Keys → Line or Memory keys as Function Keys → Memory key1 (for example).

Select the targeted Line or Memory key.

Press and or press info soft key to select the BLF in the type field.

Enter the targeted Value Number.

Press and or press info soft key to select the Account ID.

Enter the Pickup Code.

Press or Save soft key to save the configuration

To configure a BLF key by web

Click Function keys → Line or Memory key.

Select the desired Line or Memory key and select BLF in the Type.

Enter the monitored phone number in the Value field.

Select the Account ID

Filled the Pickup code.

Click the to save the configuration and then restart.

Key	Type	Value	Account	Pickup Code
Memory Key1	BLF	302	Account 1	..
Memory Key2	N/A		Account 1	
Memory Key3	N/A		Account 1	
Memory Key4	N/A		Account 1	
Memory Key5	N/A		Account 1	

NOTE

Key Type:
The free function key Type Speed Dial, BLF, Key Event, Intercom, URL.

BLF:
BLF setting require a phone restart

Note:

This feature is not available on all servers. For more information, contact your system administrator.



Shared Line



This feature allows subscribers to share SIP lines. Moreover it also provides status monitoring of the shared line.

To configure the line key as shared line via phone interface

Press Menu → Features → Function Keys → Line or Memory keys as Function Keys → Memory key1 (for example)

Select the wanted Line or Memory key.

Press  and  or press info soft key to select the Shared Line in the type field.

Press  and  or press info soft key to select the Account ID.

Enter the Label

Enter the Value

Press  or Save soft key to save the configuration

To configure the line key as shared line via Web Interface

Click Function keys → Line or Memory key.

Select the desired Line or Memory key and select Shared Line in the Type.

Enter the Value.

Enter the Label.

Select the Account ID

Click the to save the configuration and then restart.

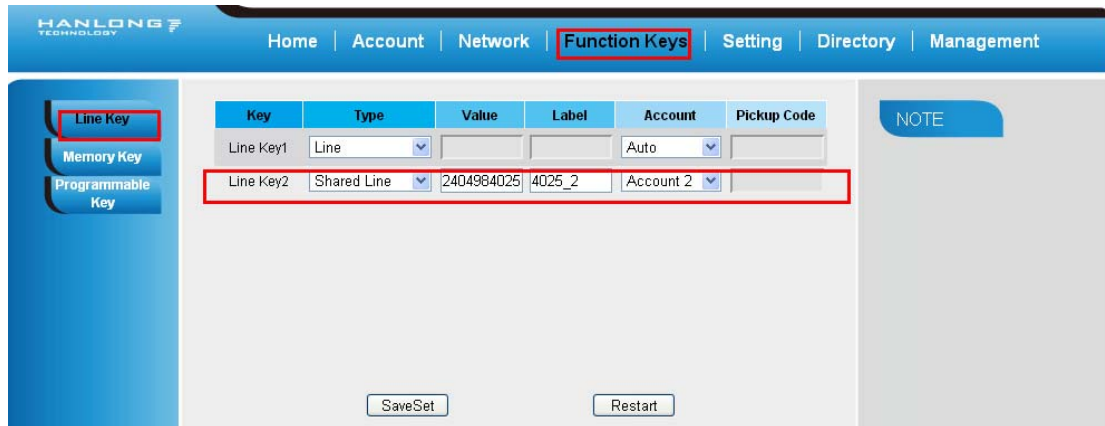

Note:

This feature is not available on all servers. For more information, contact your system administrator.

Record

With record feature, you can record calls by pressing a record key on the phone.

To configure the record via phone interface

Press Menu → Features → Function Keys → Line or Memory keys as Function Keys → Memory key1 (for example)

Select the wanted Line or Memory key.

Press and or press info soft key to select the Key Event in the type field.

Press and or press info soft key to select the Record.

Press or Save soft key to save the configuration

To configure the record via Web Interface

328. Click Function keys → Line or Memory key.

329. Select the desired Line or Memory key and select Record in the Type.

330. Click the  to save the configuration.

Note:

Please contact the system administrator whether support this feature or not.

Call Park

With this feature, you can put a call on hold and continue the conversation from another phone.

To configure the Call Park via phone interface

Press Menu → Features → Function Keys → Line or Memory keys as Function Keys → Memory key1 (for example)

Select the wanted Line or Memory key.

Press  and  or press Switch soft key to select the Key Event in the type field.

Press  and  or press Switch soft key to select the Call Park.

Press  or Save soft key to save the configuration

To configure the Call Park via Web interface

Click Function key → Line or Memory key.

Select the desired Line or Memory key and select Direct Pickup in the Type.

Click the  to save the configuration.



Paging



With this feature, you can call a phone directly.

To configure the paging via phone interface

Press Menu → Features → Function Keys → Line or Memory keys as Function Keys → Memory key1 (for example)

Select the wanted Line or Memory key.

Press  and  or press info soft key to select the Key Event in the type field.

Press  and  or press info soft key to select the Paging.

Press  or Save soft key to save the configuration

To configure the Paging via Web interface

Click Function keys → Line or Memory key.

Select the desired Line or Memory key and select Paging in the Type.



Click the  to save the configuration.

DTMF

To configure the DTMF via Phone Interface

Press Menu → Features → Function Keys → Line or Memory keys as Function Keys → Memory key1 (for example)

Select the wanted Line or Memory key.

Press  and  or press info soft key to select the DTMF in the type field.

Enter the value

Press  or Save soft key to save the configuration

To configure the DTMF via Web interface

Click Function keys → Line or Memory key.

Select the desired Line or Memory key and select DTMF in the Type.

Fill the value.

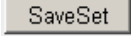
Click the  to save the configuration.

Prefix

To configure the Prefix via Phone Interface

Press Menu → Features → Function Keys → Line or Memory keys as Function Keys → Memory key1 (for example)

Select the wanted Line or Memory key.

Press  and  or press info soft key to select the Prefix in the type field.

Enter the value

Press  or Save soft key to save the configuration

To configure the Prefix via Web interface

Click Function key → Line or Memory key.

Select the desired Line or Memory key and select Prefix in the Type.

Fill the value.

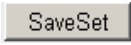
Click the  to save the configuration.

Then when you press this key, the set value is input directly.

Upgrade

Factory Reset

To set Factory Reset by phone interface

Press Menu → Setting → Advanced Setting(default password: admin)→ Factory Reset

Press OK soft key in the warning page.

To set Factory Reset via web interface

Click Management → Upgrade

Click and then confirm the setting.



Upgrade

To upgrade software, this phone can be configured with a TFTP server where the new code image is located. The TFTP upgrade can work in either static IP or DHCP mode using private or public IP address. It is recommended to set the TFTP server address in either a public IP address or on the same LAN with the phone.

To configure the TFTP server via the Web configuration interface

Input the admin password to enter the configuration screen. From there, enter the TFTP server address in the designated field towards the bottom of the configuration screen.

Once the TFTP server is configured, please power cycle the phone.

TFTP process may take as long as 1 to 2 minutes over the Internet or just 20+ seconds if it is performed on a LAN. Users are recommended to conduct TFTP upgrade in a controlled LAN environment if possible. For those who do not have a local TFTP server, Hanlong provides a NAT-friendly TFTP server on the public Internet for firmware upgrade. Please check the Service section of Hanlong’s Web site to obtain this TFTP server’s IP address.

Directory to configure local TFTP

Unzip the file and put all of them under the root directory of the TFTP server.

The PC running the TFTP server and the UC IP PHONE should be in the same LAN segment.

Go to File -> Configure -> Security to change the TFTP server's default setting from "Receive Only" to "Transmit Only" for the firmware upgrade.

Start the TFTP server, in the UC IP PHONE’s web configuration page.

Configure the Firmware Server Path with the IP address of the PC.

Update the change and reboot the unit.

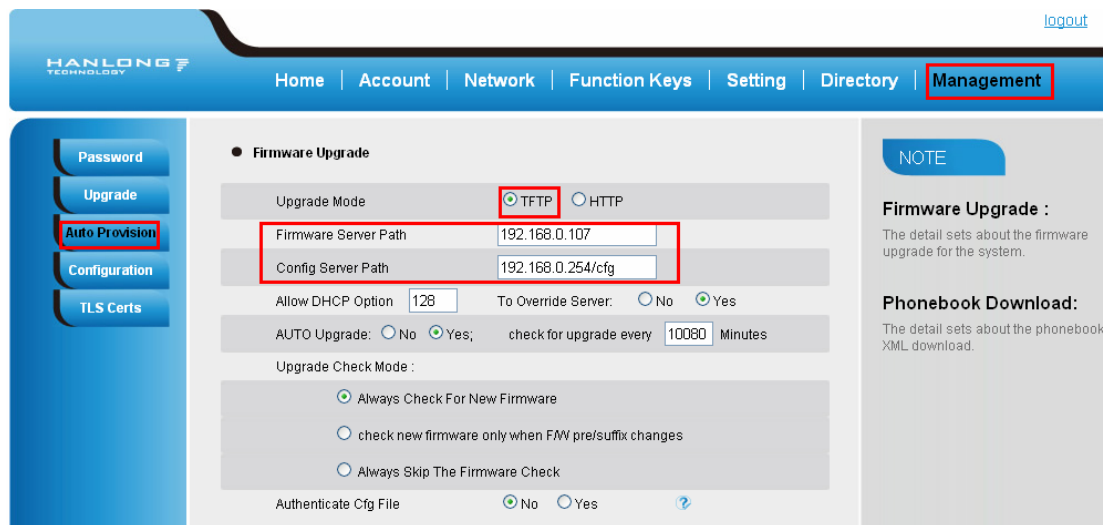

NOTES:

When Hanlong IP Phone boot up, it will send TFTP or HTTP request to download configuration files, there are two configuration files, one is “cfg.txt” and the other is “cfg001fc1xxxxxx”, where “001fc1xxxxxx” is the MAC address of the phone. These two files are for initial automatically provisioning purpose only, for normal TFTP or HTTP firmware upgrade, the following error messages in a TFTP or HTTP server log can be ignored.

Download and install a free TFTP or HTTP server to the LAN to perform firmware

upgrades. A free Windows version TFTP server is available:
http://www.solarwinds.com/products/freetools/free_tftp_server.aspx.

To upgrade manually via the Web configuration interface

Download the firmware.

Click Management → Upgrade

Click Brower or the blank.

Select the firmware and then click .

Restart.

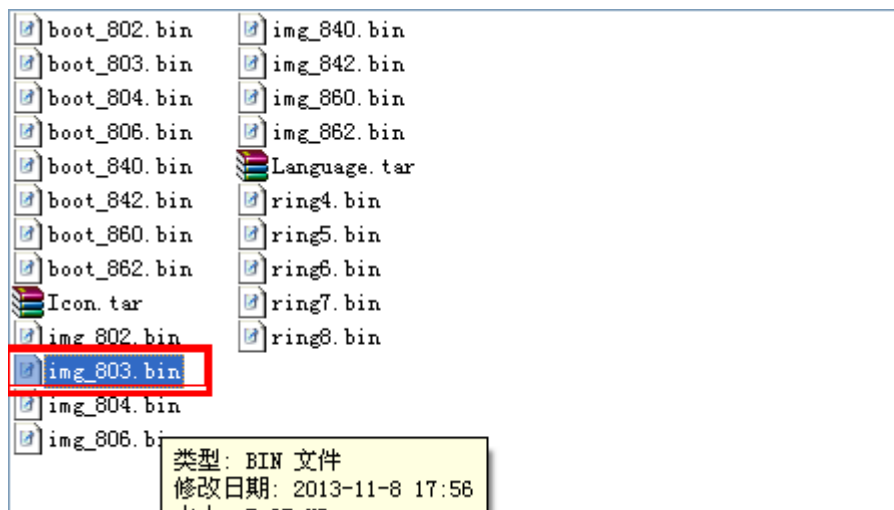
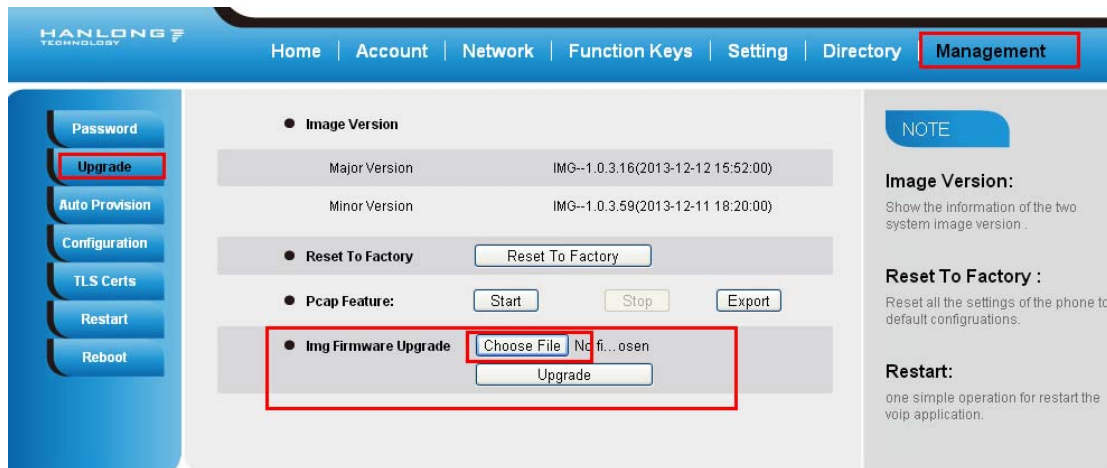

Troubleshooting

Why is the phone LCD screen blank?

Ensure your phone is properly plugged into a functional AC outlet.

Ensure that the phone isn't plugged into a plug controlled by a switch that is off.

If the phone is plugged into a power strip, try plugging it directly into a wall outlet instead.

If your phone is powered from PoE, ensure you use a PoE compliant switch or hub, or contact your system administrator for more information.

Check that the power LED is on to ensure the phone is powered on.

Why does the phone display "Network Unavailable"?

Ensure that the Ethernet cable is plugged into the Internet port on the phone and the Ethernet cable is not loose.

Ensure that the switch or hub in your network is operational.

Contact your system administrator for more information.

Why can't I get a dial tone?

Check for any loose connections and that the phone has been installed properly. For the Installation instructions, refer to [Phone Installation](#).

Check whether dial tone is present on one of the audio modes.

Switch between the Handset, Headset (if present) or Hands-Free Speakerphone to check whether dial tone is present for one of the audio modes.

If the dial tone exists on another audio mode, connect a different handset or headset to isolate the problem.